

sikla

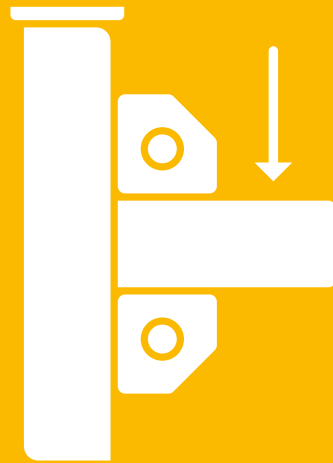

siMetrix
Static Guideline

Preliminary remarks and calculation principles	2
Beam Section	4
L-Construction	6
Frame	8
Joining Beam Bracket PRO 46-P horizontal	12
Joining Beam Bracket PRO 46-P vertical	14
T-Support	16
Beam Bracket anchored	18

Preliminary remarks and calculation principles

Area of application

The Sikla “Static Guideline” for the siMetrix 46 fastening system allows the user to easily select and plan supporting structures. It provides permissible load-bearing capacities of typical Sikla structures.

Basis and calculation principles

The design of typical Sikla structures in the ultimate limit states and serviceability limit states is based on Eurocode 0 and 3, *DIN EN 1990:2021-10*, as well as *DIN EN 1993-1-1:2010-12* and the national annex *DIN EN 1993-1-1 NA* and *DIN EN 1993-1-3:2010-12* and *DIN EN 1993-1-3 NA-2017-05*.

For the **ultimate limit state (ULS)**, the characteristic values of the load capacity of the components are reduced with a partial safety factor $\gamma_{M2} = 1.25$ according to Chapter 6.1 „General“, *DIN EN 1993-1-1:2010-12*.

The **ultimate limit states in the STR/GEO** category are verified according to *DIN EN 1990:2021-10*, Chapter 6.4 „Ultimate limit state“, according to equation 6.8: $E_d \leq R_d$.

The combination of actions in permanent or temporary design situations (basic combination) according to *Chapter 6.4.3.2, formula (6.10)* forms the basis for the verification.

The partial safety factors $\gamma_{G,j}$ for the permanent actions and $\gamma_{Q,i}$ for variable actions, as well as the combination values $\psi_{0,i}$ are taken from Table A2..4(B) - Design values of the actions (STR/GEO) - Group B.

The following applies:

- Static permanent loads G such as pipeline weights are assigned a partial safety factor $\gamma_G = 1.35$
- Variable loads Q such as additional friction forces $F_x = F_z \cdot \mu_{\text{Frict.}}$ for Sikla pipe supports on the zinc-magnesium surface of the siMetrix profiles, which are calculated from the pipe weight Fz and a static friction coefficient $\mu_{\text{Frict.}} = 0.20$ (Sikla sliding element and pipe shoe). These variable forces from the pipe expansion are assigned a partial safety factor $\gamma_Q = 1.5$.

Guided bearings with static friction coefficients $\mu_{\text{Frict.}} > 0.2$ require separate design.

The verification of the **serviceability limit states (SLS) in the STR/GEO** category is carried out in accordance with *DIN EN 1990:2021-10*, Chapter 6.5 „Serviceability limit state“, according to the equation: $E_d \leq C_d$, where C_d is the design value of the limit state for the relevant serviceability criterion.

For the Sikla structures, the serviceability criterion is deflection and deformation. Here the verification is carried out on the basis of the characteristic combination (6.14 b) in Chapter 6.5.3 „Combination of actions“. In this equation, the partial safety factors are assumed to be 1.0.

Permissible loads

The specified permissible loads correspond to the maximum characteristic permanent loads G_k and variable loads Q_k , taking into account the ultimate limit states and serviceability for the respective structure.

The influence of the connections on the ultimate limit states and serviceability limit states is taken into account in the static models by accounting for the load capacities and spring properties of the corresponding components in the calculations.

The values of the permissible loads therefore simultaneously fulfill the proof of ultimate capacity and the proof of serviceability. The relevant case in each case is listed as $F_{z, \text{perm}}$.

Connection to existing on-site structures

When fastening using anchors or connecting to existing anchor rails, the load-bearing safety proof for the products used for this purpose must be provided separately. When connecting to existing steel structures on site, its load-bearing capacity as well as its load-bearing and torsional rigidity must be tested separately. In addition, when assembling the structures using clamps, it must be ensured that the static friction between the connection set and the on-site support meets the condition $\mu_{\text{Frict.}} \geq 0.2$ (sliding surface class D).

Unless otherwise stated, the following applies:

- Force direction F_x = longitudinal axis of the support.
- Connections to concrete are dimensioned with dowel type Bolt Anchor AN BZ plus M10 hef. 60 (ETA-10/0259) in concrete strength C20/C25 under the structural specifications $h_{\text{min}} \geq 1.5 h_{\text{ef}}$ and edge distance $c \geq 120$ mm.
- Axial distances are specified by the components.

Technical information

The boundary conditions for assembling the structures are compiled in the document “siMetrix Installation Guidelines” - in particular specifications for tightening torques, screw spacing, etc.

The technical information in the respective product data sheets regarding use and application must be observed. The indicated load values also apply when using unperforated profiles.



siMetrix Installation Guidelines

Reusability of products

Products may only be reused if the specified permissible load specifications have not been exceeded and the surface protection is not damaged

Exclusion of liability

This documentation is intended for the use of the recipient only and is the property of Sikla in all its parts. The technical images and all information are provided to the best of our knowledge.

Illustrations and drawings are non-binding. Liability for printing errors is excluded.

We reserve the right to make changes and design improvements, particularly in the interests of technical progress.

Working loads in accordance with Eurocode 3

Beam Section

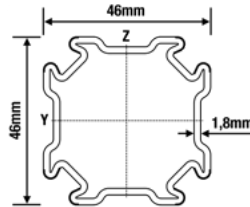
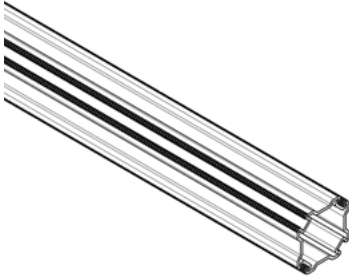

Part List
1x Profile PRO 46

Distributed Load

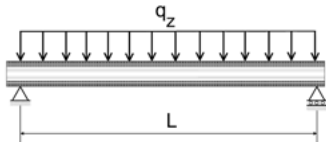

L_{max} [mm]	$q_{z,perm}$ [kN/m]	F_z ($q_{z,perm} * L$) [kN]
500	13.86	6.93
750	9.23	6.92
1000	5.53	5.53
1500	2.27	3.40
2000	0.96	1.91
2500	0.49	1.22

q_z [kN/m] as permanent load over L.

Point Load

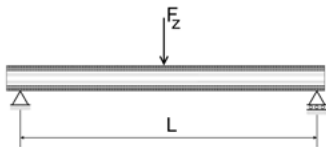

L_{max} [mm]	$F_{z,perm}$ [kN]
500	5.55
750	3.69
1000	2.76
1500	1.83
2000	1.20
2500	0.76

F_z [kN] as permanent load at distance L/2.

2 Point Loads

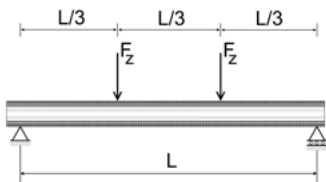

L_{max} [mm]	$F_{z,perm}$ [kN]
500	3.46
750	2.77
1000	2.07
1500	1.25
2000	0.70
2500	0.45

F_z [kN] as permanent loads at distance L/3 and 2L/3

3 Point Loads

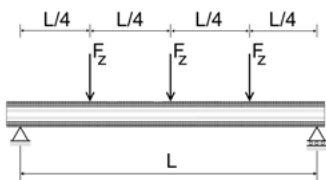

L_{max} [mm]	$F_{z,perm}$ [kN]
500	2.31
750	1.85
1000	1.38
1500	0.89
2000	0.50
2500	0.32

F_z [kN] as permanent loads at distance L/4, L/2 and 3L/4

Single-span beam with uniaxial load.
Dead weight of the profile is considered. Max. bending L/200.

Working loads in accordance with Eurocode 3

Beam Section

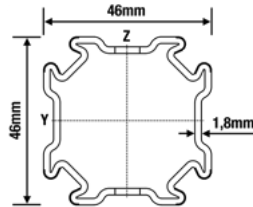

Part List
1x Profile PRO 46-P

Distributed Load	L_{max}	$q_{z, perm}$	$F_z (q_{z, perm} \times L)$
	[mm]	[kN/m]	[kN]
	500	11.76	5.88
	750	7.83	5.87
	1000	4.69	4.69
	1500	1.92	2.89
	2000	0.81	1.62
	2500	0.42	1.02

q_z [kN/m] as permanent load over L.

Point Load	L_{max}	$F_{z, perm}$
	[mm]	[kN]
	500	4.71
	750	3.13
	1000	2.34
	1500	1.55
	2000	1.01
	2500	0.65

F_z [kN] as permanent load at distance L/2.

2 Point Loads	L_{max}	$F_{z, perm}$
	[mm]	[kN]
	500	2.94
	750	2.35
	1000	1.76
	1500	1.06
	2000	0.60
	2500	0.38

F_z [kN] as permanent loads at distance L/3 and 2L/3.

3 Point Loads	L_{max}	$F_{z, perm}$
	[mm]	[kN]
	500	1.96
	750	1.57
	1000	1.17
	1500	0.76
	2000	0.43
	2500	0.27

F_z [kN] as permanent loads at distance L/4, L/2 and 3L/4.

10/2024 Single-span beam with uniaxial load.
Dead weight of the profile is considered. Max. bending L/200.

Working loads in accordance with Eurocode 3

L-Construction

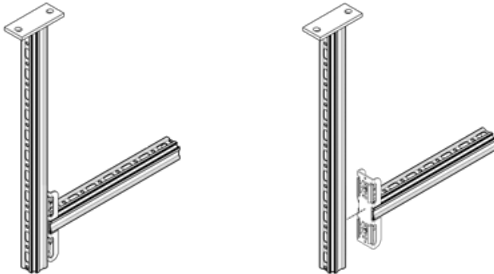

Part List

- 1x Cantilever Bracket AK 46-P
- 1x Cantilever Bracket AK CC 46-P

Distributed Load

H_{max}	L_{max}	200		400		600	
		$q_{z,perm}$	$F_z (q_z * L)$	$q_{z,perm}$	$F_z (q_z * L)$	$q_{z,perm}$	$F_z (q_z * L)$
[mm]	[mm]	[kN/m]	[kN]	[kN/m]	[kN]	[kN/m]	[kN]
300		4.70	0.94	1.28	0.51	0.56	0.34
600		3.97	0.79	1.05	0.42	0.46	0.28
900		3.31	0.66	0.89	0.36	0.39	0.23

q_z [kN/m] as permanent load over L.

Point Load

Load direction Z

H_{max}	L_{max}	200	400	600
		$F_{z,perm}$	$F_{z,perm}$	$F_{z,perm}$
[mm]	[mm]	[kN]	[kN]	[kN]
300		0.51	0.26	0.17
600		0.42	0.21	0.14
900		0.35	0.18	0.12

F_z [kN] as permanent load at distance L.

Point Load

Load directions Z and X

H_{max}	L_{max}	200		400		600	
		$F_{z,perm}$	$F_{x,perm}$	$F_{z,perm}$	$F_{x,perm}$	$F_{z,perm}$	$F_{x,perm}$
[mm]	[mm]	[kN]	[kN]	[kN]	[kN]	[kN]	[kN]
300		0.36	0.07	0.19	0.04	0.13	0.03
600		0.30	0.06	0.16	0.03	0.11	0.02
900		0.26	0.05	0.13	0.03	0.09	0.02

F_z [kN] as permanent load at distance L;
 F_x [kN] as a variable load at distance L..

2 Point Loads

Load direction Z

H_{max}	L_{max}	200	400	600
		$F_{z,perm}$	$F_{z,perm}$	$F_{z,perm}$
[mm]	[mm]	[kN]	[kN]	[kN]
300		0.34	0.17	0.11
600		0.28	0.14	0.09
900		0.23	0.12	0.08

F_z [kN] as permanent loads at distance L and L/2.

2 Point Loads

		Load directions Z and X					
		200		400		600	
H_{max}	L_{max}	$F_{z, perm}$	$F_{x, perm}$	$F_{z, perm}$	$F_{x, perm}$	$F_{z, perm}$	$F_{x, perm}$
	[mm]	[kN]	[kN]	[kN]	[kN]	[kN]	[kN]
	300	0.24	0.05	0.13	0.03	0.09	0.02
	600	0.20	0.04	0.11	0.02	0.07	0.01
	900	0.17	0.03	0.09	0.02	0.06	0.01

F_z [kN] as permanent loads at distance L and L/2;
 F_x [kN] as variable loads at distance L and L/2.

3 Point Loads

		Load direction Z		
H_{max}	L_{max}	200	400	600
	[mm]	$F_{z, perm}$	$F_{z, perm}$	$F_{z, perm}$
		[kN]	[kN]	[kN]
	300	0.24	0.13	0.08
	600	0.20	0.10	0.07
	900	0.17	0.09	0.06

F_z [kN] as permanent loads at distance L, 2L/3 and L/3.

3 Point Loads

		Load directions Z and X					
		200		400		600	
H_{max}	L_{max}	$F_{z, perm}$	$F_{x, perm}$	$F_{z, perm}$	$F_{x, perm}$	$F_{z, perm}$	$F_{x, perm}$
	[mm]	[kN]	[kN]	[kN]	[kN]	[kN]	[kN]
	300	0.18	0.04	0.10	0.02	0.06	0.01
	600	0.15	0.03	0.08	0.02	0.05	0.01
	900	0.13	0.03	0.07	0.01	0.05	0.01

F_z [kN] as permanent loads at distance L, 2L/3 and L/3;
 F_x [kN] as variable loads at distance L, 2L/3 and L/3.

All illustrated structures are able to be installed standing as well.
 Friction coefficient $\mu_0 = 0.2$ for friction in longitudinal direction. Max. deviation H/100; L/100.
 Use of the anchors must be taken into account according to local conditions.

Working loads in accordance with Eurocode 3

Frame

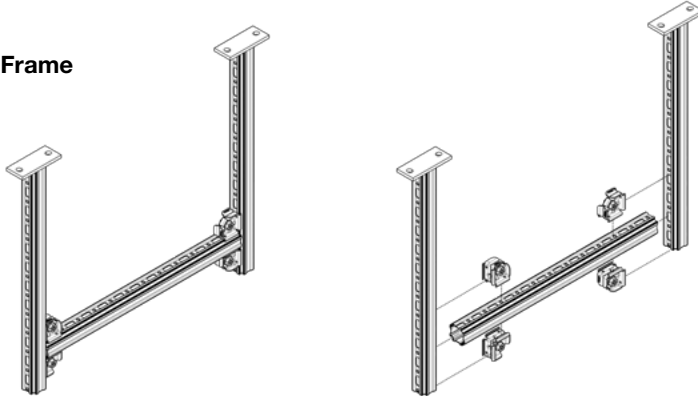

Part List

- 1x Profile PRO 46-P
- 2x Cantilever Bracket AK 46-P
- 4x Angle Connector CN 46

Distributed Load

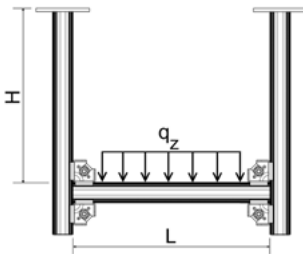

H _{max} [mm]	L _{max} 500		1000		1500		2000		2500		3000	
	q _{z, perm} [kN/m]	F _{z, perm} [kN]	q _{z, perm} [kN/m]	F _{z, perm} [kN]	q _{z, perm} [kN/m]	F _{z, perm} [kN]	q _{z, perm} [kN/m]	F _{z, perm} [kN]	q _{z, perm} [kN/m]	F _{z, perm} [kN]	q _{z, perm} [kN/m]	F _{z, perm} [kN]
300	5.96	2.98	2.98	2.98	1.95	2.92	1.11	2.22	0.61	1.53	0.37	1.12
600	5.96	2.98	2.98	2.98	1.94	2.91	1.10	2.20	0.60	1.51	0.37	1.11
900	5.96	2.98	2.98	2.98	1.94	2.91	1.09	2.17	0.60	1.49	0.37	1.10

q_z [kN/m] as permanent load over L. F_z = (q_z * L).

Point Load

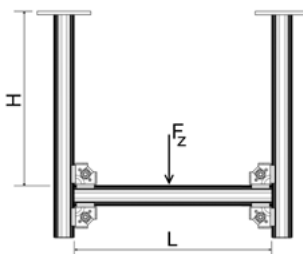

Load direction Z

H _{max} [mm]	L _{max} 500		1000		1500		2000		2500		3000	
	F _{z, perm} [kN]	F _{z, perm} [kN]	F _{z, perm} [kN]	F _{z, perm} [kN]	F _{z, perm} [kN]	F _{z, perm} [kN]	F _{z, perm} [kN]	F _{z, perm} [kN]	F _{z, perm} [kN]	F _{z, perm} [kN]	F _{z, perm} [kN]	
300	2.98	2.61	1.81	1.81	1.36	0.93	0.68					
600	2.98	2.60	1.81	1.81	1.35	0.92	0.67					
900	2.98	2.59	1.80	1.80	1.34	0.91	0.67					

F_z [kN] as a permanent load at distance L/2.

Point Load

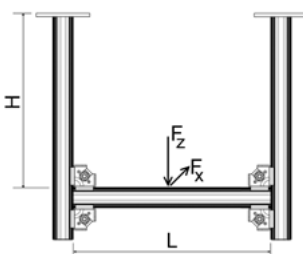

Load directions Z and X

H _{max} [mm]	L _{max} 500		1000		1500		2000		2500		3000	
	F _{z, perm} [kN]	F _{x, perm} [kN]	F _{z, perm} [kN]	F _{x, perm} [kN]	F _{z, perm} [kN]	F _{x, perm} [kN]	F _{z, perm} [kN]	F _{x, perm} [kN]	F _{z, perm} [kN]	F _{x, perm} [kN]	F _{z, perm} [kN]	F _{x, perm} [kN]
300	2.48	0.50	2.03	0.41	1.41	0.28	1.09	0.22	0.87	0.17	0.64	0.13
600	2.48	0.50	2.03	0.41	1.40	0.28	1.09	0.22	0.87	0.17	0.63	0.13
900	1.82	0.36	1.75	0.35	1.40	0.28	1.08	0.22	0.86	0.17	0.63	0.13

F_z [kN] as a permanent load at distance L/2;

F_x [kN] as a variable load at distance L/2.

2 Point Loads

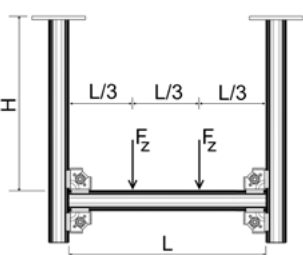

Load direction Z

H _{max} [mm]	L _{max} 500		1000		1500		2000		2500		3000	
	F _{z, perm} [kN]	F _{z, perm} [kN]	F _{z, perm} [kN]	F _{z, perm} [kN]	F _{z, perm} [kN]	F _{z, perm} [kN]	F _{z, perm} [kN]	F _{z, perm} [kN]	F _{z, perm} [kN]	F _{z, perm} [kN]	F _{z, perm} [kN]	
300	1.49	1.49	1.33	0.81	0.56	0.41						
600	1.49	1.49	1.30	0.80	0.55	0.41						
900	1.49	1.49	1.30	0.80	0.54	0.40						

F_z [kN] as permanent loads at distance 2L/3 and L/3.

2 Point Loads

Load directions Z and X

L _{max} \ H _{max}	500		1000		1500		2000		2500		3000	
	F _{z, perm}	F _{x, perm}	F _{z, perm}	F _{x, perm}	F _{z, perm}	F _{x, perm}	F _{z, perm}	F _{x, perm}	F _{z, perm}	F _{x, perm}	F _{z, perm}	F _{x, perm}
[mm]	[kN]	[kN]	[kN]	[kN]	[kN]	[kN]	[kN]	[kN]	[kN]	[kN]	[kN]	[kN]
300	1.24	0.25	1.24	0.25	1.11	0.22	0.76	0.15	0.49	0.10	0.31	0.06
600	1.24	0.25	1.24	0.25	1.11	0.22	0.76	0.15	0.49	0.10	0.31	0.08
900	0.91	0.18	0.88	0.18	0.81	0.16	0.71	0.14	0.49	0.10	0.31	0.08

F_z [kN] as permanent loads at distance 2L/3 and L/3;
F_x [kN] as variable loads at distance 2L/3 and L/3.

3 Point Loads

Load direction Z

L _{max} \ H _{max}	500	1000	1500	2000	2500	3000
	F _{z, perm}	F _{z, perm}	F _{z, perm}	F _{z, perm}	F _{z, perm}	F _{z, perm}
[mm]	[kN]	[kN]	[kN]	[kN]	[kN]	[kN]
300	0.99	0.99	0.95	0.58	0.40	0.29
600	0.99	0.99	0.94	0.58	0.40	0.29
900	0.99	0.99	0.91	0.57	0.39	0.29

F_z [kN] as permanent loads at distance 3L/4, L/2 and L/4.

3 Point Loads

Load directions Z and X

L _{max} \ H _{max}	500		1000		1500		2000		2500		3000	
	F _{z, perm}	F _{x, perm}	F _{z, perm}	F _{x, perm}	F _{z, perm}	F _{x, perm}	F _{z, perm}	F _{x, perm}	F _{z, perm}	F _{x, perm}	F _{z, perm}	F _{x, perm}
[mm]	[kN]	[kN]	[kN]	[kN]	[kN]	[kN]	[kN]	[kN]	[kN]	[kN]	[kN]	[kN]
300	0.83	0.17	0.83	0.17	0.73	0.15	0.55	0.11	0.38	0.08	0.28	0.06
600	0.83	0.17	0.83	0.17	0.73	0.15	0.54	0.11	0.37	0.07	0.27	0.05
900	0.61	0.12	0.59	0.12	0.55	0.11	0.48	0.10	0.37	0.07	0.27	0.05

F_z [kN] as permanent loads at distance 3L/4, L/2 and L/4;
F_x [kN] as variable loads at distance 3L/4, L/4 and L/4.

All illustrated structures are able to be installed standing as well.
Friction coefficient $\mu_0 = 0.2$ for friction in longitudinal direction. Max. deviation H/100; L/200.
Use of the anchors must be taken into account according to local conditions.

Working loads in accordance with Eurocode 3

Frame

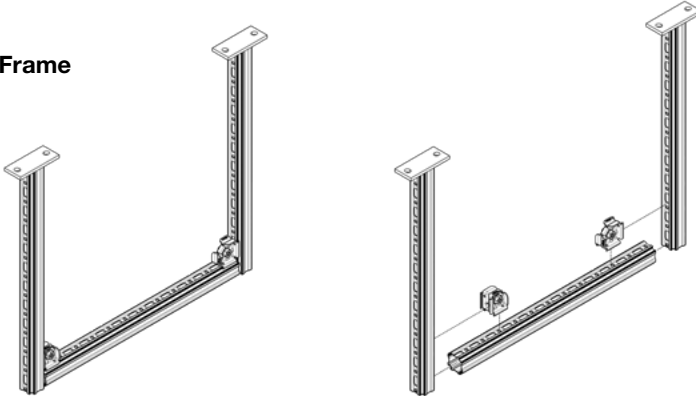

Part List

- 1x Profile PRO 46-P
- 2x Cantilever Bracket AK 46-P
- 2x Angle Connector CN 46

Distributed Load

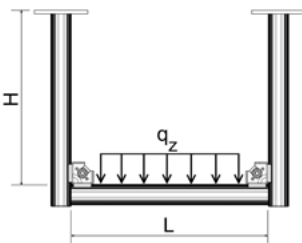

H _{max}	500		1000		1500		2000		2500		3000	
	q _{z, perm}	F _{z, perm}	q _{z, perm}	F _{z, perm}	q _{z, perm}	F _{z, perm}	q _{z, perm}	F _{z, perm}	q _{z, perm}	F _{z, perm}	q _{z, perm}	F _{z, perm}
300	2.86	1.43	1.42	1.42	0.92	1.39	0.52	1.03	0.32	0.80	0.21	0.64
600	2.83	1.42	1.40	1.40	0.92	1.39	0.52	1.03	0.32	0.80	0.21	0.64
900	2.80	1.40	1.39	1.39	0.92	1.38	0.52	1.03	0.32	0.80	0.21	0.64

q_z [kN/m] as permanent load over L. F_z = (q_z * L).

1 Point Load

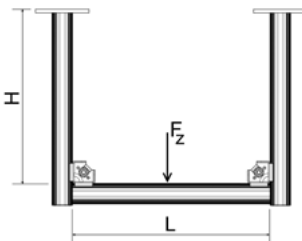

Load direction Z

H _{max}	500		1000		1500		2000		2500		3000	
	F _{z, perm}	F _{z, perm}	F _{z, perm}	F _{z, perm}	F _{z, perm}	F _{z, perm}	F _{z, perm}	F _{z, perm}	F _{z, perm}	F _{z, perm}	F _{z, perm}	
300	1.43	1.42	1.07	0.76	0.56	0.42	0.56	0.42	0.56	0.42	0.42	
600	1.42	1.40	1.07	0.76	0.56	0.42	0.56	0.42	0.56	0.42	0.42	
900	1.40	1.39	1.07	0.76	0.56	0.42	0.56	0.42	0.56	0.42	0.42	

F_z [kN] as a permanent load at distance L/2.

1 Point Load

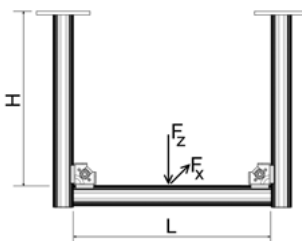

Load directions Z and X

H _{max}	500		1000		1500		2000		2500		3000	
	F _{z, perm}	F _{x, perm}	F _{z, perm}	F _{x, perm}	F _{z, perm}	F _{x, perm}	F _{z, perm}	F _{x, perm}	F _{z, perm}	F _{x, perm}	F _{z, perm}	F _{x, perm}
300	0.90	0.18	0.90	0.18	0.65	0.13	0.42	0.08	0.30	0.06	0.23	0.05
600	0.90	0.18	0.90	0.18	0.65	0.13	0.42	0.08	0.30	0.06	0.23	0.05
900	0.90	0.18	0.90	0.18	0.65	0.13	0.42	0.08	0.30	0.06	0.23	0.05

F_z [kN] as a permanent load at distance L/2;

F_x [kN] as a variable load at distance L/2.

2 Point Loads

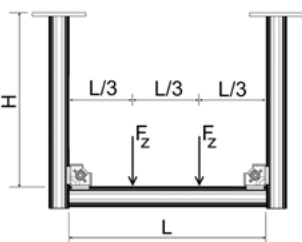

Load direction Z

H _{max}	500		1000		1500		2000		2500		3000	
	F _{z, perm}	F _{z, perm}	F _{z, perm}	F _{z, perm}	F _{z, perm}	F _{z, perm}	F _{z, perm}	F _{z, perm}	F _{z, perm}	F _{z, perm}	F _{z, perm}	
300	0.71	0.71	0.64	0.42	0.32	0.25	0.32	0.25	0.32	0.25	0.25	
600	0.71	0.70	0.59	0.42	0.32	0.25	0.32	0.25	0.32	0.25	0.25	
900	0.70	0.70	0.59	0.42	0.32	0.25	0.32	0.25	0.32	0.25	0.25	

F_z [kN] as permanent loads at distance 2L/3 and L/3.

2 Point Loads

Load directions Z and X

L _{max} \ H _{max}	500		1000		1500		2000		2500		3000	
	F _{z,perm}	F _{x,perm}	F _{z,perm}	F _{x,perm}	F _{z,perm}	F _{x,perm}	F _{z,perm}	F _{x,perm}	F _{z,perm}	F _{x,perm}	F _{z,perm}	F _{x,perm}
[mm]	[kN]	[kN]	[kN]	[kN]	[kN]	[kN]	[kN]	[kN]	[kN]	[kN]	[kN]	[kN]
300	0.56	0.11	0.56	0.11	0.50	0.10	0.36	0.07	0.26	0.05	0.20	0.04
600	0.56	0.11	0.55	0.11	0.50	0.10	0.36	0.07	0.26	0.05	0.20	0.04
900	0.55	0.11	0.55	0.11	0.50	0.10	0.36	0.07	0.26	0.05	0.20	0.04

F_z [kN] as permanent loads at distance 2L/3 and L/3;
F_x [kN] as variable loads at distance 2L/3 and L/3.

3 Point Loads

Load direction Z

L _{max} \ H _{max}	500	1000	1500	2000	2500	3000
	F _{z,perm}	F _{z,perm}	F _{z,perm}	F _{z,perm}	F _{z,perm}	F _{z,perm}
[mm]	[kN]	[kN]	[kN]	[kN]	[kN]	[kN]
300	0.48	0.47	0.46	0.30	0.23	0.18
600	0.47	0.47	0.44	0.30	0.23	0.18
900	0.47	0.46	0.42	0.30	0.23	0.18

F_z [kN] as permanent loads at distance 3L/4, L/2 and L/4.

3 Point Loads

Load directions Z and X

L _{max} \ H _{max}	500		1000		1500		2000		2500		3000	
	F _{z,perm}	F _{x,perm}	F _{z,perm}	F _{x,perm}	F _{z,perm}	F _{x,perm}	F _{z,perm}	F _{x,perm}	F _{z,perm}	F _{x,perm}	F _{z,perm}	F _{x,perm}
[mm]	[kN]	[kN]	[kN]	[kN]	[kN]	[kN]	[kN]	[kN]	[kN]	[kN]	[kN]	[kN]
300	0.38	0.08	0.37	0.07	0.35	0.07	0.25	0.05	0.19	0.04	0.14	0.03
600	0.37	0.07	0.37	0.07	0.35	0.07	0.25	0.05	0.19	0.04	0.14	0.03
900	0.37	0.07	0.37	0.07	0.35	0.07	0.25	0.05	0.19	0.04	0.14	0.03

F_z [kN] as permanent loads at distance 3L/4, L/2 and L/4;
F_x [kN] as variable loads at distance 3L/4, L/4 and L/4.

All illustrated structures are able to be installed standing as well.
Friction coefficient $\mu_0 = 0.2$ for friction in longitudinal direction. Max. deviation H/100; L/200.
Use of the anchors must be taken into account according to local conditions.

Working loads in accordance to Eurocode 3

Joining Beam Bracket PRO 46-P horizontal

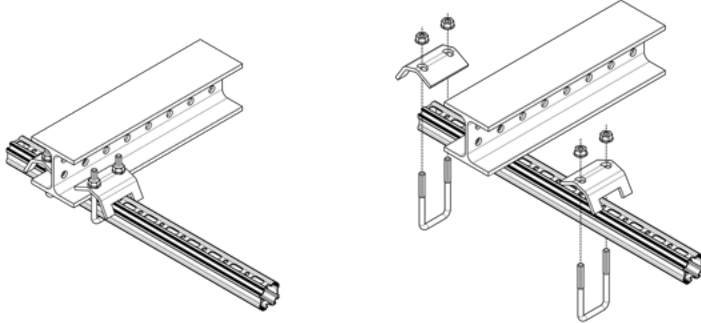

Part List

- 1x Profile PRO 46-P
- 2x U-Holder SB 46

Distributed Load		200		400		600	
		$q_{z,perm}$	$F_z (q_z * L)$	$q_{z,perm}$	$F_z (q_z * L)$	$q_{z,perm}$	$F_z (q_z * L)$
B	[mm]	[kN/m]	[kN]	[kN/m]	[kN]	[kN/m]	[kN]
100		10.20	2.04	3.06	1.23	1.44	0.87
150		13.78	2.76	4.46	1.79	2.21	1.32
200		16.17	3.23	5.52	2.21	2.82	1.69
300		19.17	3.83	6.99	2.80	3.74	2.24

q_z [kN/m] as permanent load over L.

Point Load		Load direction Z		
		200	400	600
B	[mm]	$F_{z,perm}$ [kN]	$F_{z,perm}$ [kN]	$F_{z,perm}$ [kN]
100		1.23	0.73	0.51
150		1.76	1.11	0.81
200		2.16	1.42	1.06
300		2.70	1.73	1.15

F_z [kN] as a permanent load at distance L.

Point Load		Load directions Z and X					
		200		400		600	
B	[mm]	$F_{z,perm}$ [kN]	$F_{x,perm}$ [kN]	$F_{z,perm}$ [kN]	$F_{x,perm}$ [kN]	$F_{z,perm}$ [kN]	$F_{x,perm}$ [kN]
100		0.58	0.12	0.34	0.07	0.24	0.05
150		0.84	0.17	0.52	0.10	0.38	0.08
200		1.02	0.20	0.67	0.13	0.50	0.10
300		1.28	0.26	0.91	0.18	0.70	0.14

F_z [kN] as a permanent load at distance L.;
 F_x [kN] as a variable load at distance L.

2 Point Loads		Load direction Z		
		200	400	600
B	[mm]	$F_{z,perm}$ [kN]	$F_{z,perm}$ [kN]	$F_{z,perm}$ [kN]
100		0.74	0.45	0.32
150		1.03	0.67	0.50
200		1.23	0.85	0.65
300		1.50	1.11	0.76

F_z [kN] as permanent loads at distance L and L/2.

2 Point Loads

Load directions Z and X

B [mm]	200		400		600	
	$F_{z,perm}$ [kN]	$F_{x,perm}$ [kN]	$F_{z,perm}$ [kN]	$F_{x,perm}$ [kN]	$F_{z,perm}$ [kN]	$F_{x,perm}$ [kN]
100	0.35	0.07	0.22	0.04	0.16	0.03
150	0.49	0.10	0.32	0.06	0.24	0.05
200	0.59	0.12	0.41	0.08	0.31	0.06
300	0.71	0.14	0.53	0.11	0.42	0.08

F_z [kN] as permanent loads in distance L and L/2;
 F_x [kN] as variable loads in distance L and L/2.

3 Point Loads

Load direction Z

B [mm]	200	400	600
	$F_{z,perm}$ [kN]	$F_{z,perm}$ [kN]	$F_{z,perm}$ [kN]
100	0.52	0.32	0.23
150	0.72	0.48	0.36
200	0.86	0.60	0.46
300	1.03	0.78	0.57

F_z [kN] as permanent loads at distance L, 2L/3 and L/3.

3 Point Loads

Load directions Z and X

B [mm]	200		400		600	
	$F_{z,perm}$ [kN]	$F_{x,perm}$ [kN]	$F_{z,perm}$ [kN]	$F_{x,perm}$ [kN]	$F_{z,perm}$ [kN]	$F_{x,perm}$ [kN]
100	0.25	0.05	0.16	0.03	0.11	0.02
150	0.35	0.07	0.23	0.05	0.17	0.03
200	0.41	0.08	0.29	0.06	0.22	0.04
300	0.49	0.10	0.38	0.08	0.30	0.06

F_z [kN] as permanent loads at distance L, 2L/3 and L/3;
 F_x [kN] as variable loads at distance L, 2L/3 and L/3.

Friction coefficient $\mu_0 = 0.2$ for friction in longitudinal direction. Max. deviation L/100.

Working loads in accordance to Eurocode 3

Joining Beam Bracket PRO 46-P vertical

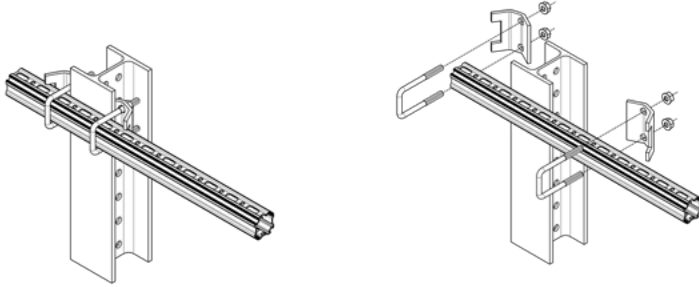

Part List

- 1x Profile PRO 46-P
- 2x U-Holder SB 46

Distributed Load		200		400		600	
		$q_{z, perm}$	$F_z (q_z * L)$	$q_{z, perm}$	$F_z (q_z * L)$	$q_{z, perm}$	$F_z (q_z * L)$
B	L_{max}	[kN/m]	[kN]	[kN/m]	[kN]	[kN/m]	[kN]
[mm]	[mm]						
100	200	2.28	0.46	0.76	0.30	0.38	0.23
150	200	2.80	0.56	1.00	0.40	0.52	0.31
200	200	3.14	0.63	1.17	0.47	0.62	0.37
300	200	3.56	0.71	1.42	0.57	0.79	0.47

q_z [kN/m] as permanent load over L.

Point Load		Load direction Z		
		200	400	600
B	L_{max}	$F_{z, perm}$	$F_{z, perm}$	$F_{z, perm}$
[mm]	[mm]	[kN]	[kN]	[kN]
100	200	0.30	0.18	0.13
150	200	0.40	0.25	0.18
200	200	0.47	0.31	0.23
300	200	0.57	0.41	0.32

F_z [kN] as a permanent load at distance L.

Point Load		Load directions Z and X					
		200		400		600	
B	L_{max}	$F_{z, perm}$	$F_{x, perm}$	$F_{z, perm}$	$F_{x, perm}$	$F_{z, perm}$	$F_{x, perm}$
[mm]	[mm]	[kN]	[kN]	[kN]	[kN]	[kN]	[kN]
100	200	0.29	0.06	0.17	0.03	0.12	0.02
150	200	0.38	0.08	0.24	0.05	0.18	0.04
200	200	0.45	0.09	0.30	0.06	0.22	0.04
300	200	0.54	0.11	0.39	0.08	0.30	0.06

F_z [kN] as a permanent load at distance L;
 F_x [kN] as a variable load at distance L.

2 Point Loads		Load direction Z		
		200	400	600
B	L_{max}	$F_{z, perm}$	$F_{z, perm}$	$F_{z, perm}$
[mm]	[mm]	[kN]	[kN]	[kN]
100	200	0.18	0.11	0.08
150	200	0.23	0.15	0.12
200	200	0.27	0.19	0.14
300	200	0.32	0.24	0.19

F_z [kN] as permanent loads at distance L and L/2.

2 Point Loads

Load directions Z and X

B [mm]	200		400		600	
	$F_{z,perm}$ [kN]	$F_{x,perm}$ [kN]	$F_{z,perm}$ [kN]	$F_{x,perm}$ [kN]	$F_{z,perm}$ [kN]	$F_{x,perm}$ [kN]
100	0.17	0.03	0.11	0.02	0.08	0.02
150	0.22	0.04	0.15	0.03	0.11	0.02
200	0.26	0.05	0.18	0.04	0.14	0.03
300	0.30	0.06	0.23	0.05	0.18	0.04

F_z [kN] as permanent loads at distance L and L/2;
 F_x [kN] as variable loads at distance L and L/2.

3 Point Loads

Load direction Z

B [mm]	200		400		600	
	$F_{z,perm}$ [kN]	$F_{z,perm}$ [kN]	$F_{z,perm}$ [kN]	$F_{z,perm}$ [kN]	$F_{z,perm}$ [kN]	$F_{z,perm}$ [kN]
100	0.13	0.08	0.08	0.06	0.06	0.06
150	0.16	0.11	0.11	0.08	0.08	0.08
200	0.19	0.13	0.13	0.10	0.10	0.10
300	0.22	0.17	0.17	0.14	0.14	0.14

F_z [kN] as permanent loads at distance L, 2L/3 and L/3.

3 Point Loads

Load directions Z and X

B [mm]	200		400		600	
	$F_{z,perm}$ [kN]	$F_{x,perm}$ [kN]	$F_{z,perm}$ [kN]	$F_{x,perm}$ [kN]	$F_{z,perm}$ [kN]	$F_{x,perm}$ [kN]
100	0.12	0.02	0.08	0.02	0.06	0.01
150	0.16	0.03	0.11	0.02	0.08	0.02
200	0.18	0.04	0.13	0.03	0.10	0.02
300	0.21	0.04	0.16	0.03	0.13	0.03

F_z [kN] as permanent loads at distance L, 2L/3 and L/3;
 F_x [kN] as variable loads at distance L, 2L/3 and L/3.

Friction coefficient $\mu_0 = 0.2$ for friction in longitudinal direction. Max. deviation L/100.

Working loads in accordance with Eurocode 3

T-Support

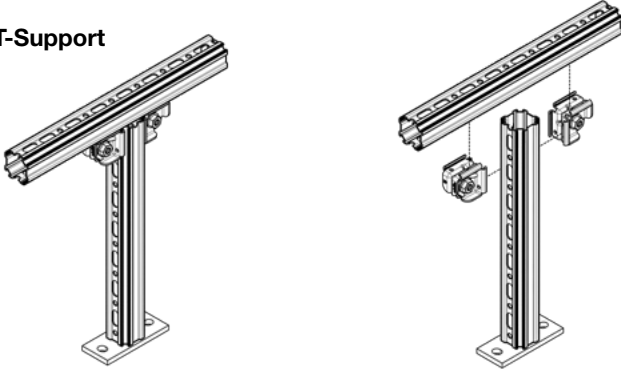

Part List

- 1x Profile PRO 46-P
- 1x Cantilever Bracket AK 46-P
- 2x Angle Connector CN 46

Distributed Load	L_{max}	250		500		750	
		$q_{z, perm}$	$F_z (q_z * L)$	$q_{z, perm}$	$F_z (q_z * L)$	$q_{z, perm}$	$F_z (q_z * L)$
	H_{max}	[kN/m]	[kN]	[kN/m]	[kN]	[kN/m]	[kN]
	250	22.60	5.65	6.56	3.28	2.90	2.18
	500	22.60	5.65	6.53	3.26	2.89	2.17
	750	22.60	5.65	6.47	3.23	2.88	2.16
	1000	22.60	5.65	6.39	3.20	2.85	2.14

q_z [kN/m] as permanent load over L.

Point Load	L_{max}	Load direction Z	
		$L_{max} = 1$ m	$F_{z, perm}$
	H_{max}	[mm]	[kN]
	250		2.83
	500		2.83
	750		2.76
	1000		2.52

F_z [kN] as a permanent load at distance L/2.
Central load introduction for planned eccentricity ± 30 mm.

Point Load	L_{max}	Load directions Z and X	
		$L_{max} = 1$ m	$F_{x, perm}$
	H_{max}	[kN]	[kN]
	250	2.59	0.52
	500	1.32	0.26
	750	0.79	0.16
	1000	0.55	0.11

F_z [kN] as a permanent load at distance L/2; F_x as a variable load at distance L/2;
Central load introduction for planned eccentricity ± 30 mm.

2 Point Loads	L_{max}	Load direction Z		
		$F_{z, perm}$	$F_{z, perm}$	$F_{z, perm}$
	H_{max}	[kN]	[kN]	[kN]
	250	1.64	0.82	0.54
	500	1.63	0.82	0.54
	750	1.62	0.81	0.54
	1000	1.60	0.81	0.54

F_z [kN] as a permanent load at distance L.

2 Point Loads

Load directions Z and X

H _{max} [mm]	250		500		750	
	F _{z, perm} [kN]	F _{x, perm} [kN]	F _{z, perm} [kN]	F _{x, perm} [kN]	F _{z, perm} [kN]	F _{x, perm} [kN]
250	1.10	0.22	0.55	0.11	0.36	0.07
500	0.75	0.15	0.55	0.11	0.36	0.07
750	0.44	0.09	0.44	0.09	0.36	0.07
1000	0.30	0.06	0.30	0.06	0.30	0.06

F_z [kN] as permanent loads at distance L.
F_x [kN] as variable loads at distance L.

3 Point Loads

Load direction Z

H _{max} [mm]	250	500	750
	F _{z, perm} [kN]	F _{z, perm} [kN]	F _{z, perm} [kN]
250	1.41	0.82	0.54
500	1.41	0.81	0.54
750	1.41	0.81	0.54
1000	1.41	0.80	0.54

F_z [kN] as permanent loads at distance L and L/2.

3 Point Loads

Load directions Z and X

H _{max} [mm]	250		500		750	
	F _{z, perm} [kN]	F _{x, perm} [kN]	F _{z, perm} [kN]	F _{x, perm} [kN]	F _{z, perm} [kN]	F _{x, perm} [kN]
250	1.10	0.22	0.55	0.11	0.36	0.07
500	0.50	0.10	0.50	0.10	0.36	0.07
750	0.30	0.06	0.30	0.06	0.30	0.06
1000	0.20	0.04	0.20	0.04	0.20	0.04

F_z [kN] as a permanent loads at distance L and L/2.
F_x [kN] as variable loads at distance L and L/2.

Standing installation only.
Friction coefficient $\mu_0 = 0.2$ for friction in longitudinal direction. Max. deviation H/150 and L/150.
Use of the anchors must be taken into account according to local conditions.

Working loads in accordance with Eurocode 3

Beam Bracket anchored

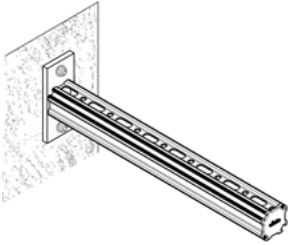

Part List
 1x Cantilever Bracket AK 46-P
 2x AN BZ plus M10 hef. 60 (Concrete C20/25)

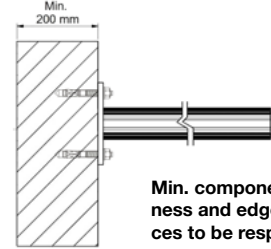
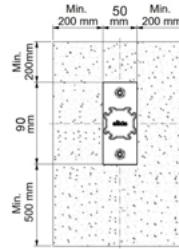

Min. component thickness and edge distances to be respected

Distributed Load

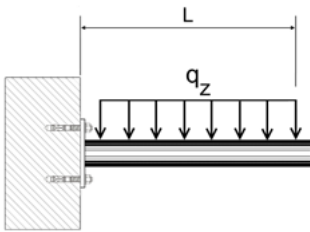

Load direction Z		
L_{max} [mm]	$q_{z, perm}$ [kN/m]	$F_z (q_z \cdot L)$ [kN]
200	14.71	2.94
400	4.29	1.71
600	1.73	1.04
800	0.89	0.71
1000	0.53	0.53

q_z [kN/m] as permanent load at distance L.

Point Load

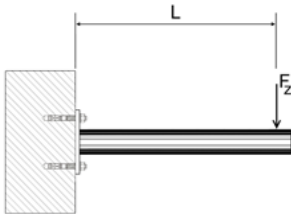

Load direction Z	
L_{max} [mm]	$F_{z, perm}$ [kN]
200	1.84
400	0.80
600	0.48
800	0.32
1000	0.23

F_z [kN] as permanent load at distance L.

Point Load

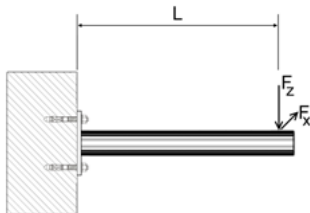

Load directions Z and X		
L_{max} [mm]	$F_{z, perm}$ [kN]	$F_{x, perm}$ [kN]
200	1.59	0.32
400	0.78	0.16
600	0.48	0.10
800	0.32	0.06
1000	0.23	0.05

F_z [kN] as permanent load at distance L;
 F_x [kN] as a variable load at distance L.

2 Point Loads

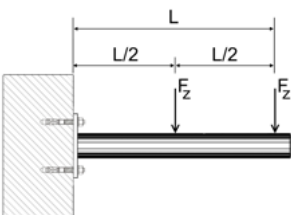

Load direction Z	
L_{max} [mm]	$F_{z, perm}$ [kN]
200	1.23
400	0.55
600	0.33
800	0.22
1000	0.16

F_z [kN] as permanent loads at distance L and L/2.

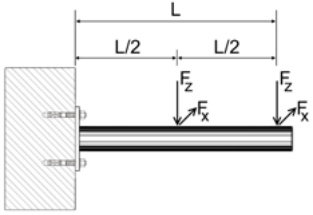
2 Point Loads	Load directions Z and X		
	L_{max} [mm]	$F_{z,perm}$ [kN]	$F_{x,perm}$ [kN]
	200	1.06	0.21
	400	0.52	0.10
	600	0.33	0.07
	800	0.22	0.04
	1000	0.16	0.03

F_z [kN] as permanent loads at distance L and L/2
 F_x [kN] as variable loads at distance L and L/2.

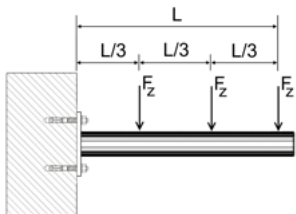
3 Point Loads	Load direction Z	
	L_{max} [mm]	F_z ($q_z \cdot L$) [kN]
	200	0.90
	400	0.42
	600	0.25
	800	0.17
	1000	0.13

F_z [kN] as permanent loads at distance L, 2L/3 and L/3.

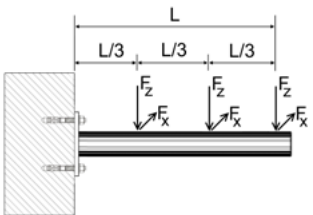
3 Point Loads	Load directions Z and X		
	L_{max} [mm]	$F_{z,perm}$ [kN]	$F_{x,perm}$ [kN]
	200	0.80	0.16
	400	0.39	0.08
	600	0.25	0.05
	800	0.17	0.03
	1000	0.13	0.03

F_z [kN] as permanent loads at distance L, 2L/3 and L/3;
 F_x [kN] as variable loads at distance L, 2L/3 and L/3.

Friction coefficient $\mu_0 = 0.2$ for friction in longitudinal direction. Max. deviation L/100.

Load values also valid with the following anchors:

VMU plus + VMU-A (5.8) M10

VMZ + VMZ-A 60 M10

